

STUDEBAKER CUT-OUT CARS AND TRUCKS

Your MO/IL Gateway Studebaker Drivers Club collection of paper/cardboard cut-out Studebakers and Avanti's. Some are pre-colored, and some are blank for one to make in their favorite color. Fun for small and adult kids alike! Credit to the source has been given when possible. I did the Champ truck years ago. Enjoy! Ed Meyer



The first item on the next page is a 1950 Studebaker card that when cut out from the black background, folds in on itself with a small slit (cut) around the right/front bumper.

**1950 STUDEBAKER
Commander Regal Deluxe**

Cost: \$1,871.

Like other car companies, Studebaker halted production with the war in '42. After the war, they hired Loewy Associates and got their new postwar designs out ahead of the other car companies in '46 and '47. This proved to be a successful strategy. In 1950 the Loewy Studios produced the famous "bullet-nose." The innovative streamlined design made Studebaker one of the most advanced cars on the road, and the company had its best year in 1950. The demise of the company fourteen years later, was probably due more to the price-cutting wars by Ford and Chevy, which smaller companies such as Studebaker could not match, than to the product itself.



© 1984 PAPER HOUSE PRODUCTIONS
A10-150
PO BOX 172 WOODSTOCK, N.Y. 12488



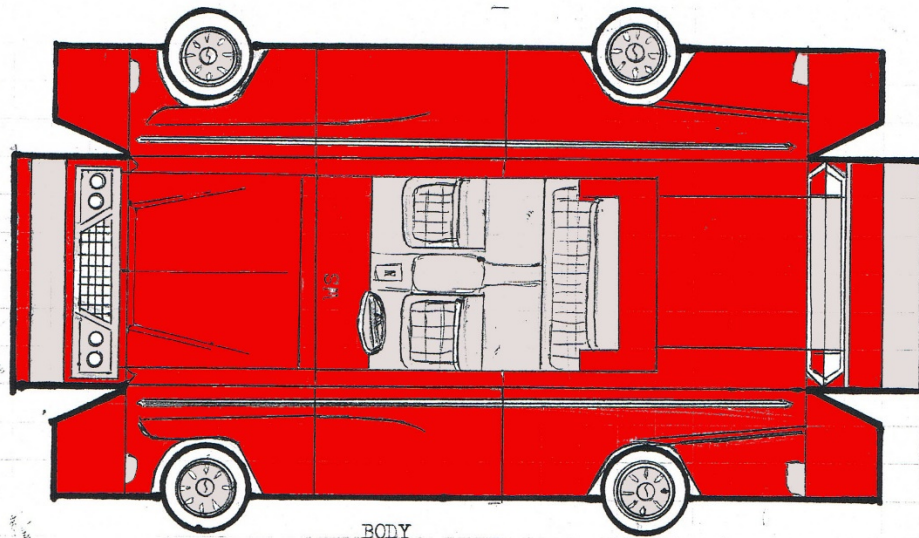

BODY



WINDSHIELD

1964 Studebaker Convertible

1. Cut out parts along thick black lines.
2. Fold the body together, forming a box, along thin, black lines.
3. Fold windshield along thin, black lines.
4. Glue body together. Let dry.
5. Glue windshield to body, where marked 'WS'
6. Display your completed Studebaker.

'64 Daytona Cut-Out & Assemble"

By: John Cosco

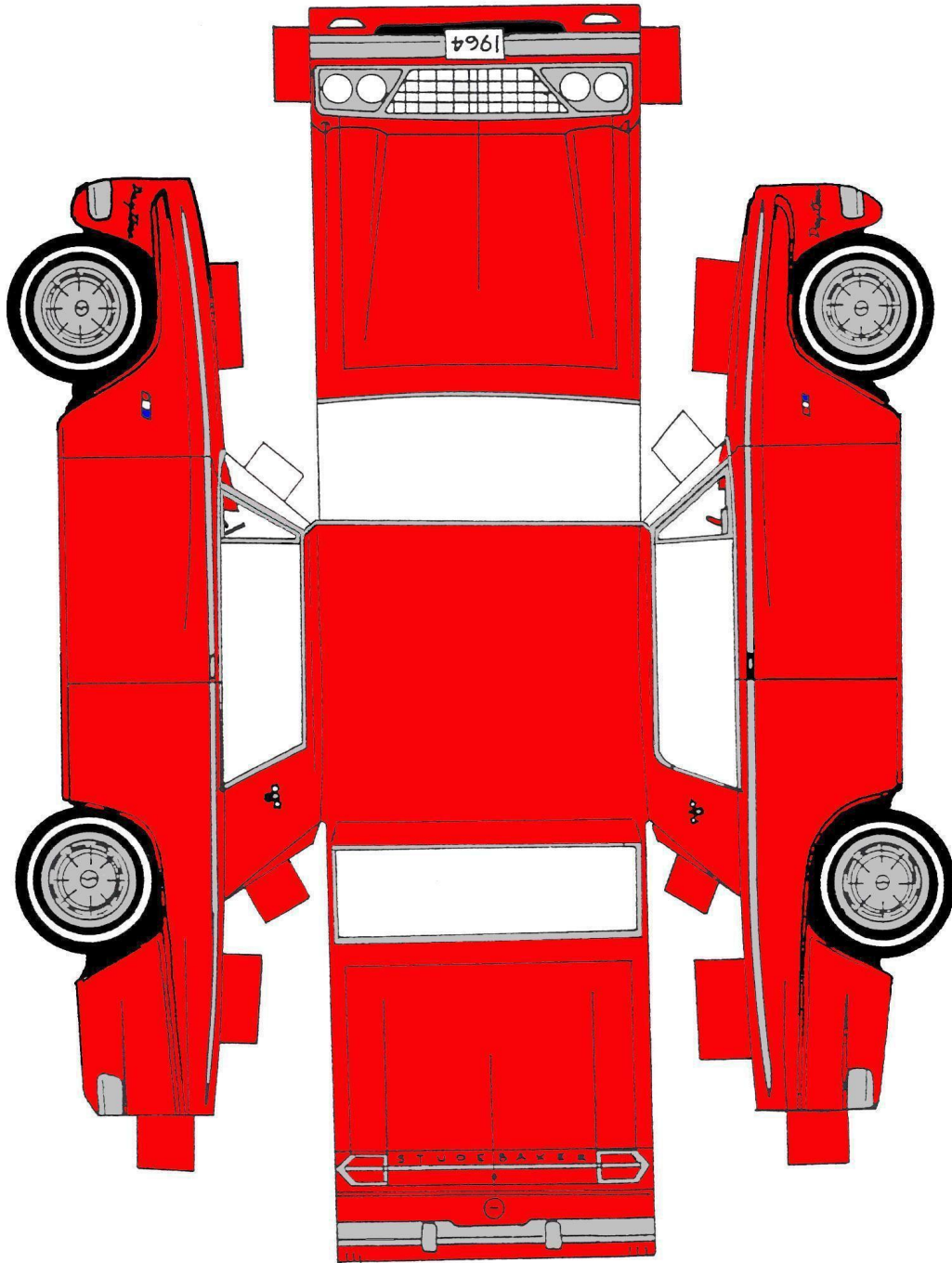

Merry Christmas SDC Kids

(AND GROWNUPS, TOO)

'64 Daytona "Color, Cut-Out & Assemble"

By: John Cosco

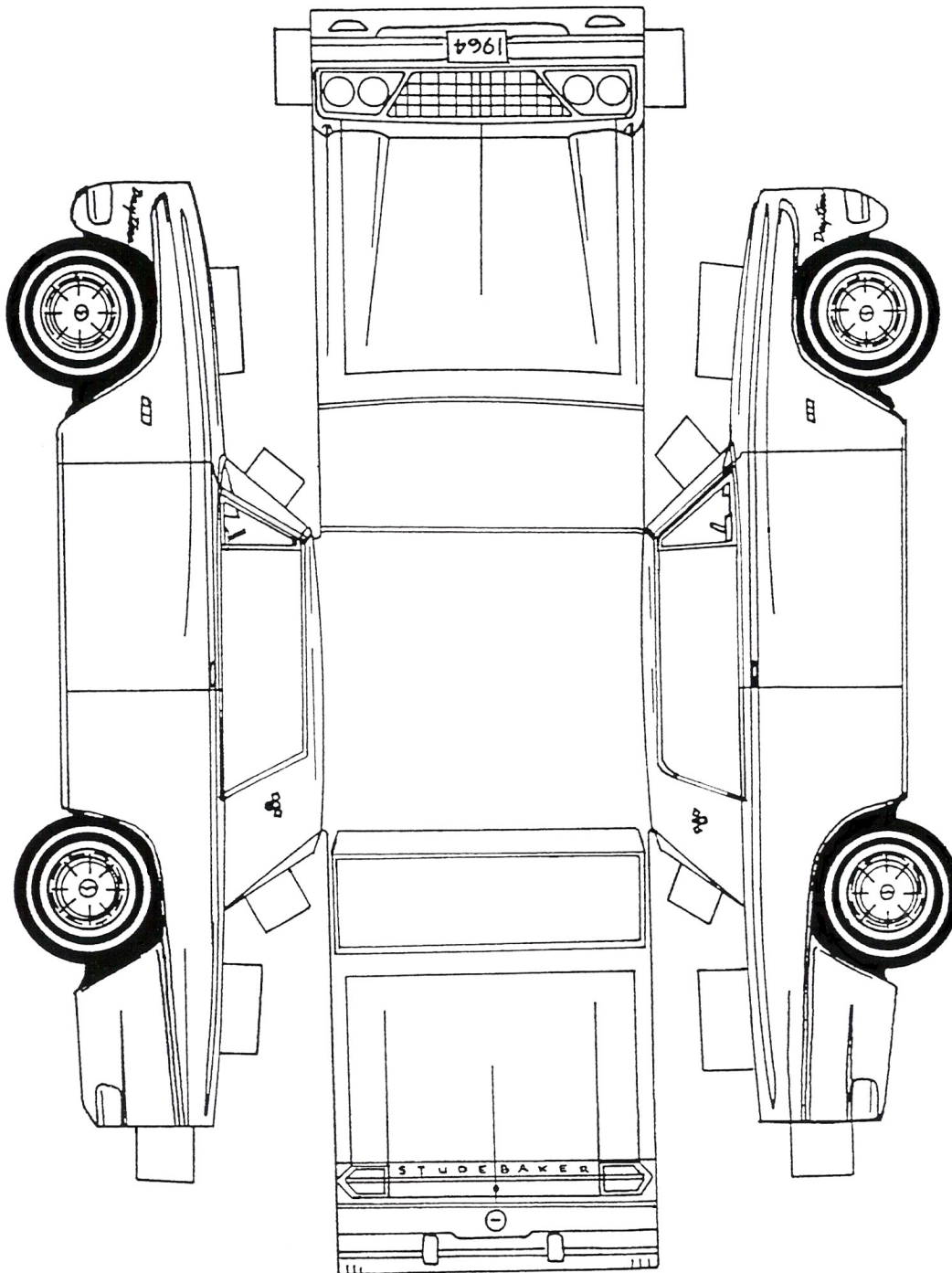

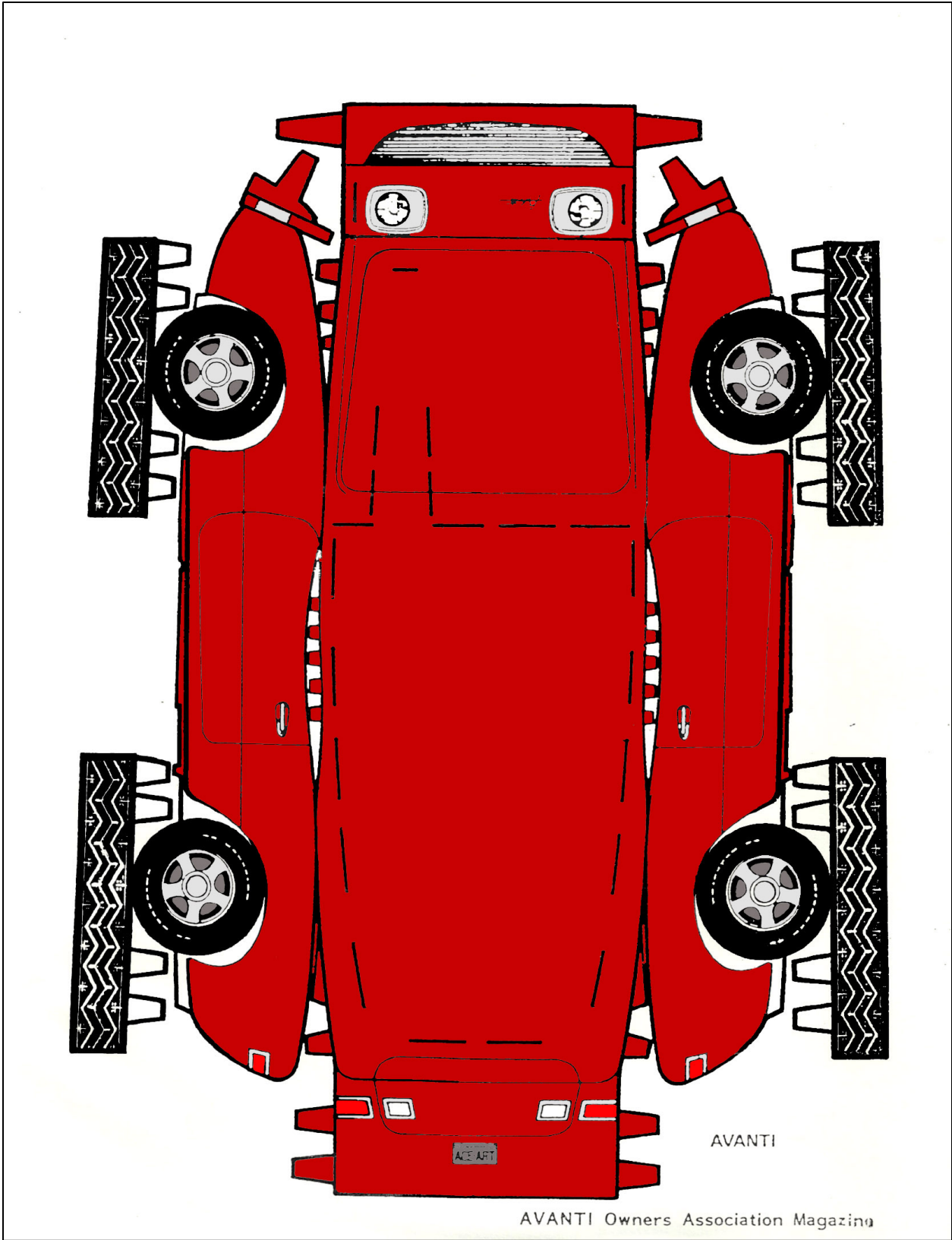

AVANTI Owners Association Magazine

HAND BUILD YOUR OWN AVANTI

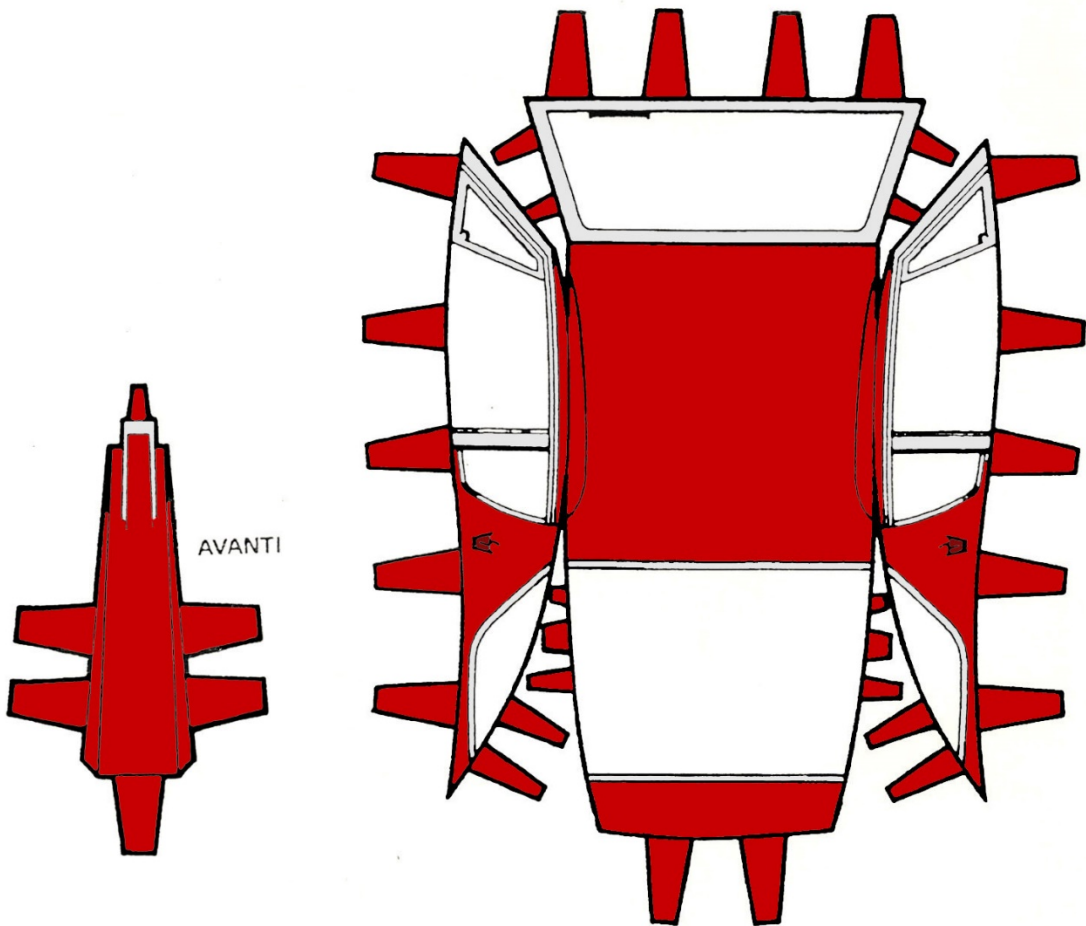

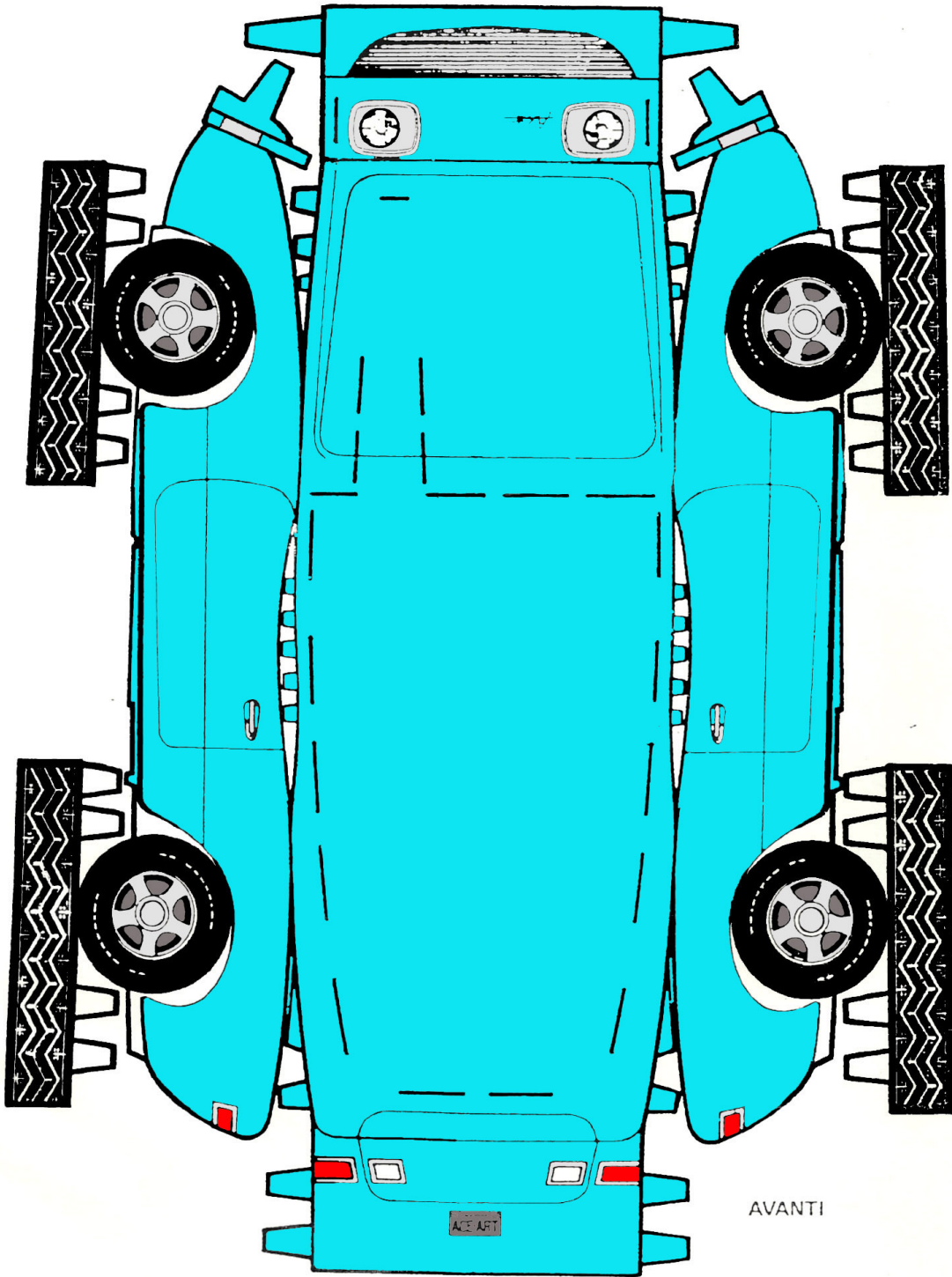

AVANTI

HAND BUILD YOUR OWN AVANTI

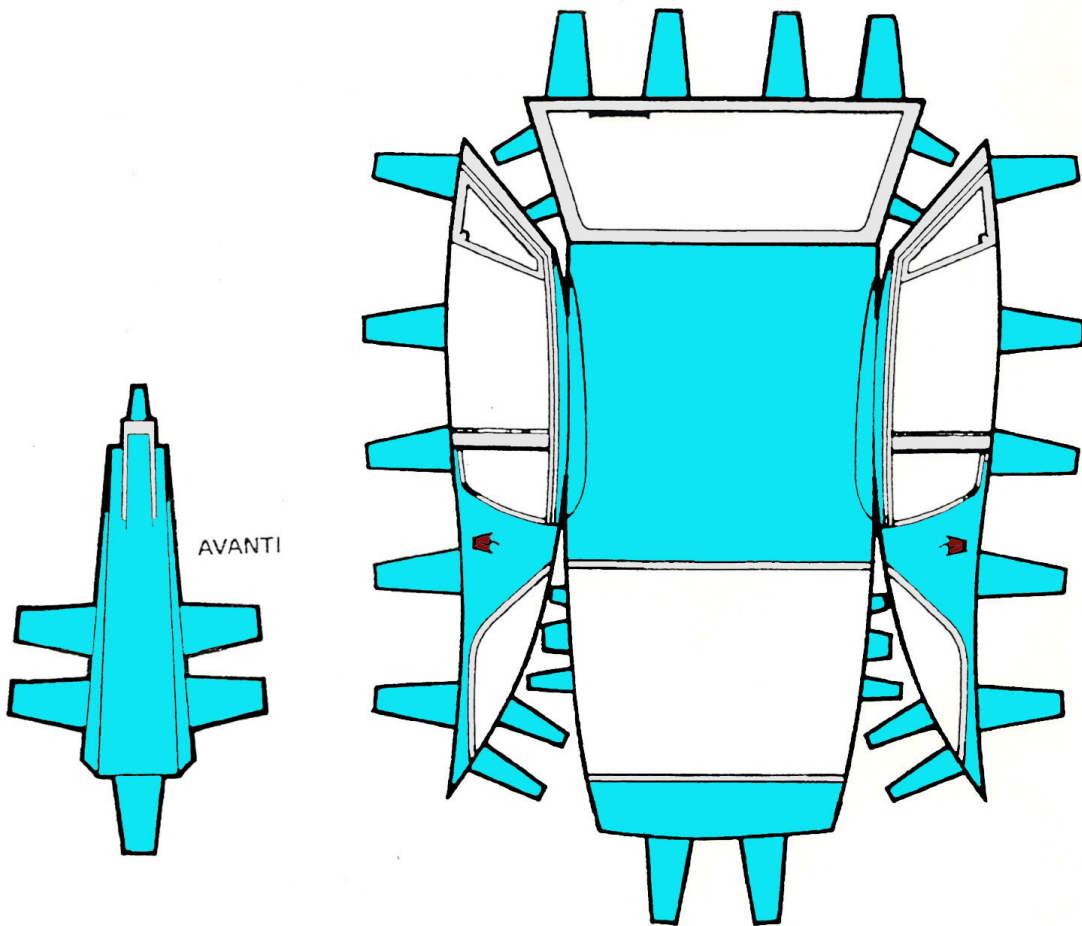

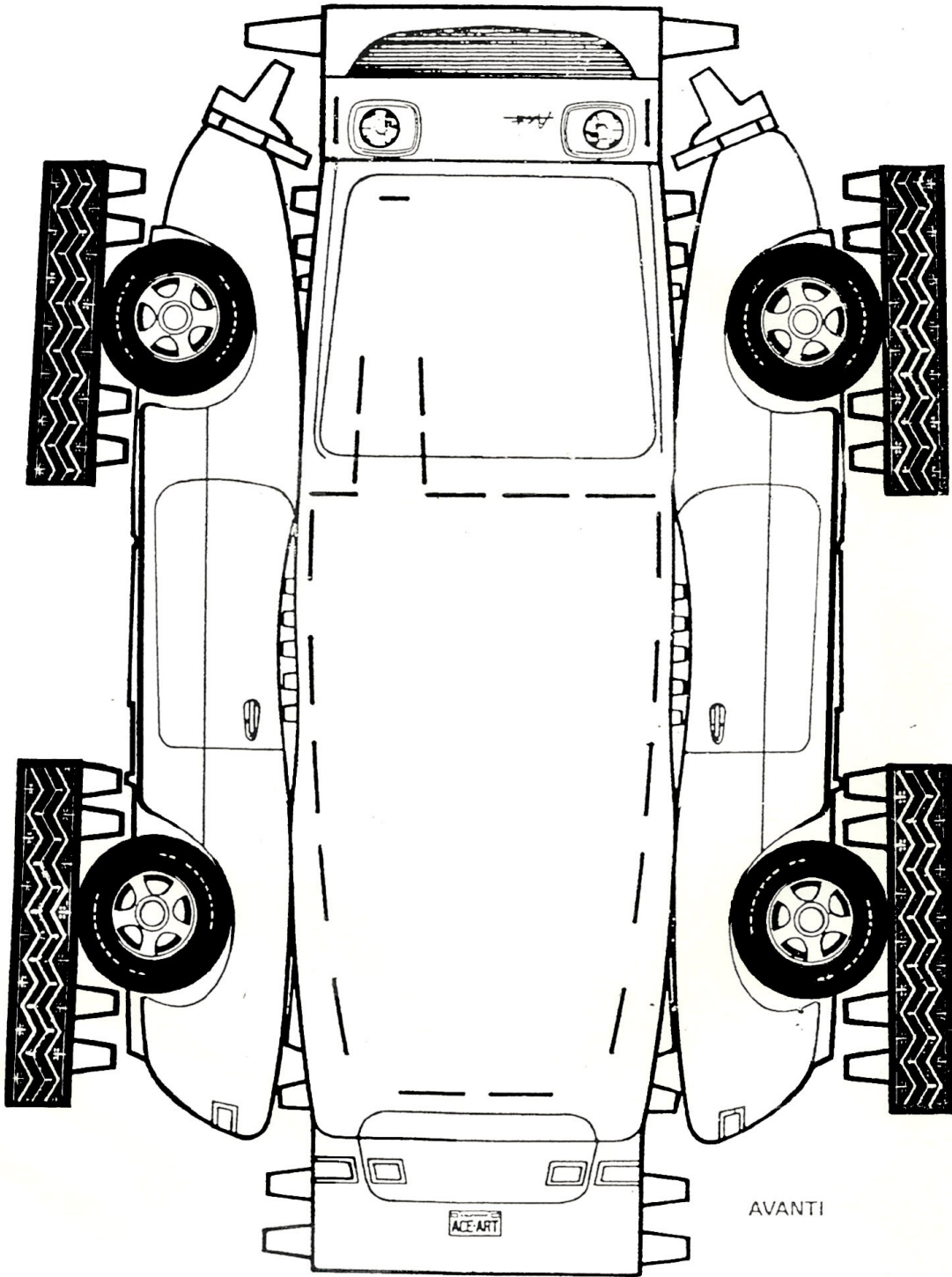

AVANTI

AVANTI Owners Association Magazine

HAND BUILD YOUR OWN AVANTI

